

02 Bilge Pumping Systems

INTRODUCTION

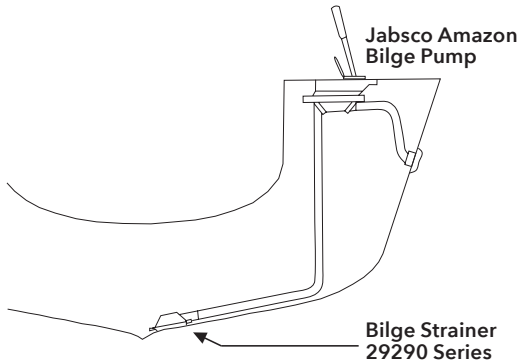

Manual Diaphragm Pumps



These are the traditional mainstay of small craft bilge pumping systems and can offer surprisingly good flow rates, as well as a variety of installation options. Yacht racing rules state that at least one pump must be capable of being pumped from the cockpit with all hatches shut. The best way to accomplish this is with a through deck kit, which allows the pump to be installed safely below decks while the operator pumps from above.

A well-designed manual bilge pump is very hard to block due to its large bore hose and valves and one-piece diaphragm. The larger pumps in Jabsco's line of manual bilge pumps are also suitable for ballast and waste transfer.

Electric Submersible Pumps

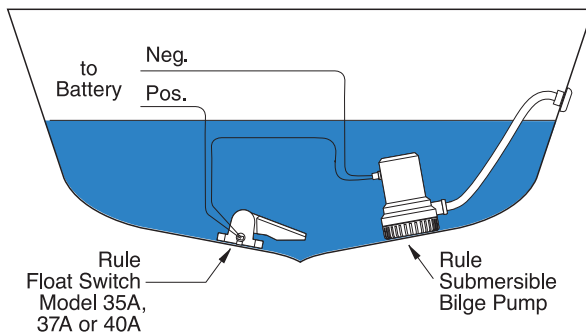

By far the most popular type of electric bilge pumps, submersibles give very high outputs, are cost effective, have low amp draw and are easy to install. They are designed to fit in the lowest part of the bilge and only require discharge pipework and electricity supply. However, flow rates decrease as the discharge head increases, so check our recommended maximum discharge heads, and if in doubt, always increase the size of the pump. Although our submersibles can be run dry for up to two hours, pump life can be extended by avoiding dry running whenever possible. All submersibles can be operated using a float or Hydro Air switch, and remotely controlled outside the bilge compartment by using a Rule switch panel.

Electric Diaphragm Pumps

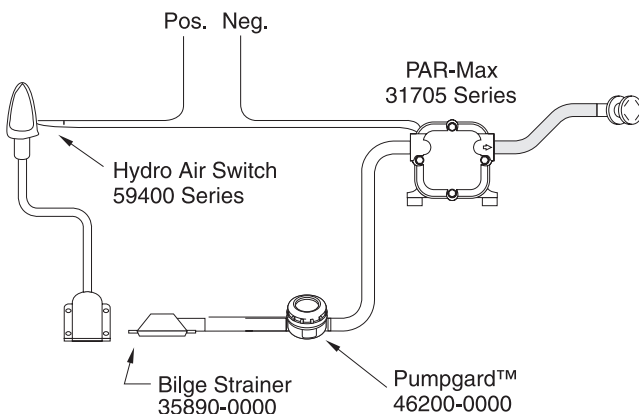

These pumps are excellent for shallow bilge boats, where the water left behind by other types of pumps will slop from side to side. With the small size of inlet plumbing, they are very effective as bilge pumps, removing all but the last drops of water. Diaphragm pumps can be run dry, which removes the need to watch overboard outlets while the pump is running. The ability to self-prime means they can be mounted in an easily accessible, high and dry location to simplify installation and improve serviceability. Most models in the line are supplied complete with a Pumpgard™ strainer to protect the pumps from bilge debris.

Electric Flexible Impeller Pumps

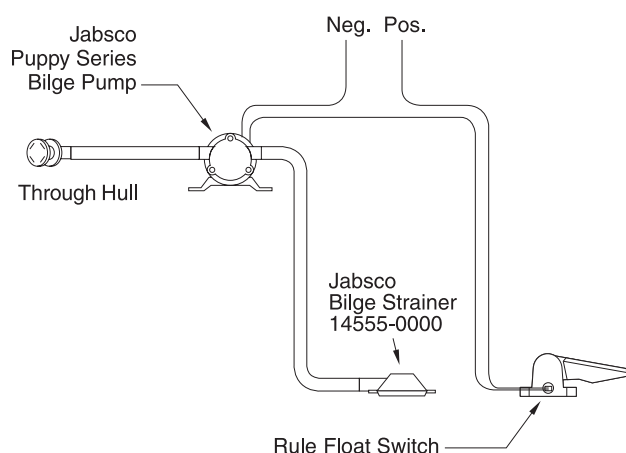

Flexible impeller pumps make excellent bilge pumps, principally because of their ability to handle bilge debris without damage. Because of the robust design, many owners still use our 12 volt DC or 24 volt DC flexible impeller motor pump units that are up to 25 years old! Flexible impeller pumps also give the benefits of good flow, low cost, low size and weight, and are easily serviced and maintained. Most flexible impeller pumps must not be run dry, as this will damage the impeller and require replacing. However, the Utility Puppy 2000 and 3000 both allow a maximum of 10 minutes dry running after initial prime. Flexible impeller pumps can be operated using a float or Hydro Air switch, and remotely controlled from outside the bilge compartment. There is a wide range of flexible impeller pumps to choose from, giving a range of flows, discharge heads and self-priming options for applications such as ballast transfer, bait tank circulation and deck wash duties.

Engine Driven Flexible Impeller Pumps

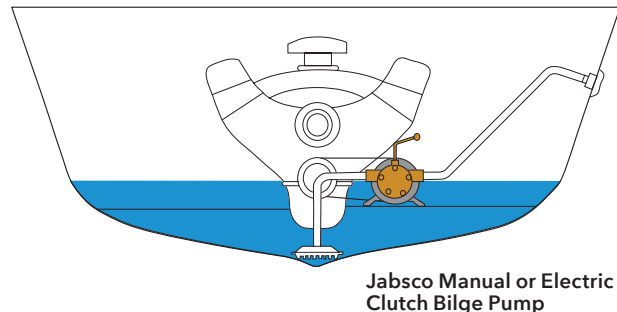

Jabsco Engine Driven Pumps are probably the strongest and most reliable pumps produced today. Combined with other benefits such as self-priming and very high flow rates, these pumps are now the firm favorites of commercial and professional mariners worldwide. All the pumps are easily maintained and can fulfill a variety of duties onboard both modern and classic vessels. Jabsco engine driven pumps come in a very wide range of performances and sizes, and can be direct driven by a clutch, pulley or hydraulic drive, or close coupled to a suitable power take-off on the engine. These pumps are suitable for applications such as:

- High-flow, heavy-duty bilge pumps.
- Emergency onboard bilge pumps.
- Firefighting pumps.
- Engine cooling.
- Water ballast transfer.
- Circulation duties.

Of course, each application requires different features from each pump and drive type. Either manual or electromagnetic flexible impeller clutch pumps are ideal for bilge pumping. Each type of clutch has different benefits from the other. Manual clutches will operate as long as the engines are still running, which provides added security when operating as an emergency bilge pump. Electromagnetic clutches can be operated remotely via float or Hydro Air switches, while fitting a vacuum switch eliminates all risk of dry running damage. However, electromagnetic clutches will only engage as long as electrical power remains available.



WARNING

No pump manufactured by Jabsco or Rule should be used for gasoline, petroleum products or any fluid with a flash point below 100°F (38°C).

02 Bilge Pumping Systems

INTRODUCTION



Rule Bilge Pumps

Rule Submersible Bilge Pumps have set the standard for the industry for decades. They are the first choice of yachtsmen and fishermen throughout the world. More innovations in bilge pump design have come from Rule Industries than any other manufacturer, and we are proud to offer the broadest range of bilge pumps in the world.

Rule Industries has taken the initiative to once again set the standard. We're moving forward to redesign our bilge pumps from the 360 to the 4000 GPH pumps. As we look into the future, you'll see new designs, more options and higher efficiencies.



FEATURES AND BENEFITS

- Pump and switch are stand-alone products.
- Compact, efficient, long-life motors.
- Sizes: 360, 500, 800, 1000, 1100, 1500, 2000, 3700 and 4000 in 12, 24 and 32 volt versions.
- Limited three-year warranty.
- Ability to run dry for short periods.
- Easy-clean, snap-lock strainer bases.
- Stainless steel shafts.
- Completely submersible.
- Marine-grade blocked wiring.
- Rust and corrosion protection.
- Silent and vibrationless operation.
- CE and ISO 8849 certification.
- Ignition protection.
- Traditional operation activated by a float switch and/or panel switch, providing an extra level of security and protection.
- Remove the motor by pushing the side tabs, allowing easy access to clean the strainer and the impeller cavity.

Standard Bilge Pumps

CAPACITY GPH (LPH)	MODEL NUMBER	VOLTS	FUSE SIZE	AMPS @12V	AMPS @13.6V	REPLACEMENT STRAINER	HEIGHT INCHES (mm)	WIDTH INCHES (mm)	HOSE DIAMETER INCHES (mm)	PANEL SWITCHES	FLOAT SWITCHES
360 (1363)	24	12DC	4	2.2	2.7	Model 275	3.5 (89)	2.4 (60)	3/4 (19)	41, 43, 45, 49	35A, 37A, 40A
500 (1893)	25D-6 (6' wires)	12DC	4	1.9	2.2	Model 275	3.5 (89)	2.4 (60)	3/4 (19)	41, 43, 45, 49	35A, 37A, 40A
500 (1893)	25D	12DC	4	1.9	2.2	Model 275	3.5 (89)	2.4 (60)	3/4 (19)	41, 43, 45, 49	35A, 37A, 40A
500 (1893)	26D	24DC	1.5	0.9@24V	1.3@27V	Model 275	3.5 (89)	2.4 (60)	3/4 (19)	42, 44, 45, 49	35A, 37A, 40A
800 (3028)	21R	24DC	2.5	1.3@24V	2.0@27V	Model 275	3.75 (95)	2.4 (60)	3/4 (19)	42, 44, 45, 49	35A, 37A, 40A
800 (3028)	20R	12DC	5	2.2	2.5	Model 275	3.75 (95)	2.4 (60)	3/4 (19)	41, 43, 45, 46	35A, 37A, 40A
800 (3028)	20F	12DC	5	2.1	2.5	Model 277	4.0 (102)	2.9 (73)	3/4 (19)	41, 43, 45, 47	35A, 37A, 40A
900 (3407)	LP900D	12DC	7.5	4	5	1230R	2.4 (60)	2.4 (60)	Multiple	41, 43, 45, 48	35A, 37A, 40A
1000 (3785)	20A	12DC	5	2.6	3.2	Model 277	4.0 (102)	2.9 (73)	1-1/8 (29)	41, 43, 45, 49	35A, 37A, 40A
1100 (4164)	28D	24DC	2.5	1.3@24V	2.0@27V	Model 275	4.25 (108)	2.4 (60)	1-1/8 (29)	42, 44, 45, 49	35A, 37A, 40A
1100 (4164)	27D-6 (6' wires)	12DC	5	2.8	3.4	Model 275	4.25 (108)	2.4 (60)	1-1/8 (29)	41, 43, 45, 49	35A, 37A, 40A
1100 (4164)	27D	12DC	5	2.8	3.4	Model 275	4.25 (108)	2.4 (60)	1-1/8 (29)	41, 43, 45, 49	35A, 37A, 40A
1500 (5678)	04	12DC	10	4	4.8	Model 278	6 (152)	4.25 (108)	1-1/8 (29)	41, 43, 45, 49	35A, 37A, 40A
1500 (5678)	03	24DC	4	2.3@24V	3.5@27.2V	Model 278	6 (152)	4.25 (108)	1-1/8 (29)	42, 44, 45, 49	35A, 37A, 40A
1500 (5678)	02-6 (6' wires)	12DC	10	4	4.8	Model 278	6 (152)	4.25 (108)	1-1/8 (29)	41, 43, 45, 49	35A, 37A, 40A
1500 (5678)	02	12DC	10	4	4.8	Model 278	6 (152)	4.25 (108)	1-1/8 (29)	41, 43, 45, 49	35A, 37A, 40A
2000 (7571)	12	24DC	7.5	4.0@24V	6.0@27.2V	Model 278	6 (152)	4.25 (108)	1-1/8 (29)	42, 44, 45, 49	35A, 37A, 40A
2000 (7571)	11	32DC	6	3.1@32V	5.0@36.3V	Model 278	6 (152)	4.25 (108)	1-1/8 (29)	–	35A, 37A, 40A
2000 (7571)	10-6UL	12DC	15	7.3	8.6	Model 278	6 (152)	4.25 (108)	1-1/8 (29)	41, 43, 45, 49	35A, 37A, 40A
2000 (7571)	10	12DC	15	7.3	8.6	Model 278	6 (152)	4.25 (108)	1-1/8 (29)	41, 43, 45, 49	35A, 37A, 40A
2000 (7571)	09	12DC	15	7.3	8.6	Model 278	6 (152)	4.25 (108)	1-1/8 (29)	41, 43, 45, 49	35A, 37A, 40A
3700 (14010)	15A	32DC	10	5.0@32V	7.5@36.3V	Model 279	7.25 (184)	4.9 (124)	1-1/2 (38)	–	37A, 40A
3700 (14010)	16A	24DC	15	6.9@24V	10@27.2V	Model 279	7.25 (184)	4.9 (124)	1-1/2 (38)	42, 44, 45, 49	37A, 40A
3700 (14010)	14A-6UL	12DC	25	10.1	12.2	Model 279	7.25 (184)	4.9 (124)	1-1/2 (38)	41, 43, 45, 49	37A, 40A
3700 (14010)	14A	12DC	25	10.1	12.2	Model 279	7.25 (184)	4.9 (124)	1-1/2 (38)	41, 43, 45, 49	37A, 40A
3700 (14010)	13A	12DC	25	10.1	12.2	Model 279	7.25 (184)	4.9 (124)	1-1/2 (38)	41, 43, 45, 49	37A, 40A
4000 (15140)	56D-32	32DC	10	5.0@32V	7.5@36.3V	Model 279	7.75 (196.8)	4.75 (121)	2 (51)	–	37A, 40A
4000 (15140)	56D-24	24DC	15	6.9@24V	10@27.2V	Model 279	7.75 (196.8)	4.75 (121)	2 (51)	42, 44, 45, 49	37A, 40A
4000 (15140)	56D	12DC	25	10.2	12.1	Model 279	7.75 (196.8)	4.75 (121)	2 (51)	41, 43, 45, 49	37A, 40A

02 Bilge Pumping Systems

ELECTRIC SUBMERSIBLE PUMPS



Electronic Sensing Bilge Pumps

Electronic sensing operation on the principle of impeller resistance. Float switches are not required.

The pump will turn on every 2-1/2 minutes for about one second to sense for water. If water is present, the pump will sense resistance and continue to run until all water is removed. Thereafter, it will check for water every 2-1/2 minutes. Power use in the checking mode is minimal.



FEATURES AND BENEFITS

- No external switch.
- Pump operates automatically by sensing for water.
- Pump turns on every 2-1/2 minutes to feel for water. When water is encountered, the pump remains on until water is removed and then the pump shuts down. Thereafter, it reverts to a 2-1/2 minute sensing mode.
- Sizes: 500, 800, 1100, 1500, 2000, 3700 and 4000 in 12 and 24 volt versions.
- Limited three-year warranty.

Rule-Mate Automated Bilge Pumps

No float switch required. The Rule-Mate series of bilge pumps features a solid state water sensing technology that eliminates the need for a separate float switch.

When water enters the bilge and reaches a certain height, 2-3/4" (70mm), a sensor turns the pump on. After the water is pumped out, another sensor shuts the pump off. The sensors' unique "field effect" technology is eco-friendly because they only sense the dielectric constant of water. In the event of an onboard oil spill, straight motor oil that enters the bilge will not turn the pump on. Please note that this is **not** an oil overspill system or a safety measure device.

FEATURES AND BENEFITS

- All-in-one pump and switch – no float switch required.
- Pump turns on when water level rises and shuts off when water is removed.
- Will not pump oil – straight motor oil that enters the bilge will not turn the pump on.
- Snap-off strainer for easy cleaning.
- Anti-fouling impeller.
- The new Rule-Mates are available in 500, 750, 1100, 1500 and 2000 GPH (1893, 2839, 4164, 5678 and 7571 LPH) models in 12 and 24 volt versions.
- Limited three-year warranty.



RM2000A

ELECTRONIC SENSING SERIES BILGE PUMPS

CAPACITY GPH (LPH)	MODEL NUMBER	VOLTS	FUSE SIZE	AMPS @12V	AMPS @13.6V	REPLACEMENT STRAINER	HEIGHT INCHES (mm)	WIDTH INCHES (mm)	HOSE DIAMETER INCHES (mm)	PANEL SWITCHES
500 (1893)	25S-6 (6' wires)	12DC	2.5	1.9	2.5	Model 275	4 (102)	2.4 (60)	3/4 (19)	41, 43, 45
500 (1893)	25S	12DC	2.5	1.9	2.5	Model 275	4 (102)	2.4 (60)	3/4 (19)	41, 43, 46
500 (1893)	25S-24	24DC	1.5	0.9@24V	1.3@27.2V	Model 275	4 (102)	2.4 (60)	3/4 (19)	41, 43, 47
800 (3028)	20RS	12DC	5	3.7	4.3	Model 275	4.25 (108)	2.4 (60)	3/4 (19)	41, 43, 45
1100 (4164)	27S	12DC	6	2.8	3.4	Model 275	4.25 (108)	2.4 (60)	1-1/8 (29)	41, 43, 45
1500 (5678)	51S	12DC	10	4.8	7	Model 286	7.75 (196.8)	4.75 (121)	1-1/8 (29)	41, 43, 45
2000 (7571)	53S	12DC	15	8.4	12	Model 278	7.75 (196.8)	4.75 (121)	1-1/8 (29)	41, 43, 45
3700 (14010)	55S	12DC	25	15.5	20	Model 279	8.25 (209.5)	4.9 (124)	1-1/2 (38)	41, 43, 45
4000 (15140)	56S	12DC	25	15.5	20	Model 279	9.25 (235)	4.9 (124)	2 (51)	41, 43, 45

RULE-MATE AUTOMATED BILGE PUMPS

CAPACITY GPH (LPH)	MODEL NUMBER	VOLTS	FUSE SIZE	AMPS @12V	AMPS @13.6V	REPLACEMENT STRAINER	HEIGHT INCHES (mm)	WIDTH INCHES (mm)	HOSE DIAMETER INCHES (mm)	PANEL SWITCHES
500 (1893)	RM500A	12DC	3	2	2.2	Model 1000864-26	4.5 (114)	6 (152)	3/4 (19)	41, 43, 45
500 (1893)	RM500A-24	24DC	1.5	1.0@24V	1.3@27.2V	Model 1000864-26	4.5 (114)	6 (152)	3/4 (19)	42, 44, 45
750 (2839)	RM750A	12DC	5	2.8	3.1	Model 1000864-26	4.5 (114)	6 (152)	3/4 (19)	41, 43, 45
750 (2839)	RM750A-24	24DC	3	1.4@24V	2.0@27.2V	Model 1000864-26	4.5 (114)	6 (152)	3/4 (19)	42, 44, 45
1100 (4164)	RM1100A	12DC	5	3.4	4	Model 1000864-26	4.5 (114)	6 (152)	1-1/8 (29)	41, 43, 45
1100 (4164)	RM1100A-24	24DC	3	1.4@24V	2.0@27.2V	Model 1000864-26	4.5 (114)	6 (152)	1-1/8 (29)	42, 44, 45
1500 (5678)	RM1500A	12DC	10	4.8	7	Model 286	6 (152)	7.25 (185)	1-1/8 (29)	41, 43, 45
2000 (7571)	RM2000A	12DC	15	12	12	Model 286	6 (152)	7.25 (185)	1-1/8 (29)	41, 43, 45
2000 (7571)	RM2000A-24	24DC	7.5	4.0@24V	6.0@27.2V	Model 286	6 (152)	7.25 (185)	1-1/8 (29)	41, 43, 45

LoPro Bilge Pumps

LOW PROFILE BILGE PUMPS FOR TIGHT SPACES

Designed to bring pumping power to tight spaces, Rule's LoPro Series Bilge Pumps are only 2.4" (6cm) high. The LP900S model features two automated modes. The first one engages the pump when the water level reaches 2" (5cm) or 1.3" (3.25cm) (user choice); and the second one checks for water by briefly turning on the pump every 2-1/2 minutes. The LP900D model uses a traditional float and/or panel switch for operation.

FEATURES AND BENEFITS

- Multiple modes of operation. The LP900S features two automated modes of operation.
- High or low water sensing mode. The pump starts when water reaches 2" (5cm). By turning the motor cartridge upside down, the sensor is at 1.3" (3.25cm).
- Electronic automatic mode. The pump automatically turns on every 2-1/2 minutes to check for water, and if it's detected, the pump stays on until the water is gone.
- Fully rotating discharge body. The entire body swivels up to 180°, making for an easy plumbing installation.
- Threaded discharge nozzle. Multiple ports are available for this pump: 3/4" (19mm) straight, 3/4" (19mm) right angle, 1" (25mm) and 1-1/8" (28mm).
- All ports are included in the aftermarket package.
- New tricuspid check valves help prevent backflow.
- Horizontal or vertical mounting. The LP900S and LP900D feature a variety of mounting options to accommodate a boat's bilge.



LP900S



LP900D

CAPACITY GPH (LPH)	MODEL NUMBER	VOLTS	AMPS @12V	AMPS @13.6V	FUSE SIZE	HEIGHT INCHES (mm)	WIDTH INCHES (mm)	LENGTH INCHES (mm)	HOSE DIAMETER INCHES (mm)	PANEL SWITCHES	FLOAT SWITCHES
Automatic											
900 (3407)	LP900S	12DC	4	5.2	7.5	2.4 (60)	2.4 (60)	9 (228)	Multiple	42, 44, 45	–
Standard											
900 (3407)	LP900D	12DC	4	5.2	7.5	2.4 (60)	2.4 (60)	7.12 (180)	Multiple	43, 45	35A, 37A, 40A

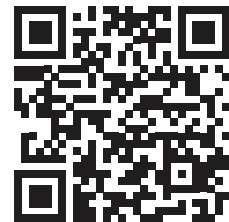

02 Bilge Pumping Systems

BILGE PUMP CONTROL & PANEL SWITCHES



SuperSwitch™ Float Switch



37A

Backed by a five-year warranty, the non-mercury SuperSwitch™ is designed for the toughest applications. Design includes marine-grade, 14 gauge blocked wire, a larger float for increased buoyancy, removable base for easy servicing and a snap switch design capable of handling pumps drawing up to 20 amps at 12 volt DC. Models 37A and 37FA include a five-year warranty.

Rule-A-Matic® Plus™ Float Switch



40A

Sleek and rugged, the Rule-a-Matic® Plus™ Float Switch has a strong, fully integrated and impact-resistant cover, which protects against debris and jamming. Design includes 14 gauge highly abrasive-resistant, marine-grade wire and a built-in test feature. Designed for pumps drawing up to 20 amps at 12 volt DC. Models 40A and 40FA include a two-year warranty.

Rule-A-Matic® Float Switch



35A

Year after year, the Rule-a-Matic® has been the switch of choice for boaters the world over. Our latest design now includes a removable base for easy cleaning and servicing, a mercury-free snap switch tested to over one million cycles and marine-grade blocked wire. Designed for pumps drawing up to 14 amps at 12 volt DC. Models 35A and 35FA include a two-year warranty.

ECO-Switch



39

The Rule ECO-Switch is an ecologically sound automatic bilge pump control switch. Featuring a non-mercury design, the pump operates with simple air pressure. As water rises in the bilge, air rises in the air tube that is attached to the switch. The air pressure activates the switch which controls your pump. All wiring is out of the water, and there are no submerged electrical connections at all. Offering complete reliability and outstanding performance, the Rule ECO-Switch offers a viable alternative to traditional float switches. For pumps drawing up to 20 amps.

MODEL NUMBER	DESCRIPTION	VOLTS (DC)	MAX AMPS (DC)	WIRE GAUGE	SIZE (HEIGHT X LENGTH X WIDTH) INCHES (mm)
35A	Rule-a-Matic®	12, 24	14A (12V), 7A (24V)	16 AWG	2-1/4 x 5 x 1-3/4 (57 x 127 x 58)
35FA	Rule-a-Matic® with in-line fuse holder	12, 24	14A (12V), 7A (24V)		
37A	SuperSwitch™	12, 24, 32	20A (12V), 10A (24V), 6.5A (32V)	14 AWG	2-1/4 x 5 x 2 (57 x 127 x 51)
37FA	SuperSwitch™ with in-line fuse holder	12, 24, 32	20A (12V), 10A (24V), 6.5A (32V)		
40A	Rule-a-Matic® Plus™ with shield	12, 24, 32	20A (12V), 10A (24V), 6.5A (32V)	14 AWG	3 x 5-3/8 x 2-1/2 (76 x 137 x 64)
40FA	Rule-a-Matic® Plus™ with shield and in-line fuse holder	12, 24, 32	20A (12V), 10A (24V), 6.5A (32V)		
39	ECO-Switch 12 volt	12	20A	14 AWG	1-7/8 x 6 x 2-3/4 (48 x 152 x 70)
39-24	ECO-Switch 24 volt	24	10A		

3-Way Panel Lighted Switch

Model
41/42



For use with any automatically controlled pump. Toggle has three positions (automatic, off or manual) and a "fail-safe" spring return to "off" from the "manual" position. Panel is black stainless steel with a red indicator light and fuse holder.

3-Way Panel Switch

Model 45



Similar to the Lighted Panel Switch, but without the indicator light or fuse holder. The "manual" position has a "fail-safe" spring return to "off" so you can't leave your pump running by accident. Black stainless steel panel.

3-Way Panel with Lighted Rocker Switch

Model
43/44



For use with any automatically controlled pump. This unit features a black plastic panel, a built-in fuse holder, an internally lighted rocker switch with three positions (automatic, off or manual) and the Rule "fail-safe" spring return to "off" from the "manual" position.

2-Way Panel Switch

Model 49



Attractive black stainless steel panel highlights your control panel. Simple "on" and "off" toggle provides fingertip control.

MODEL NUMBER	DESCRIPTION	VOLTS (DC)	MAX AMPS (DC)	SIZE (WIDTH X HEIGHT), INCHES (mm)
41	3-Way Panel Switch – Lighted	12	20	3-1/4 x 2 (83 x 51)
42	3-Way Panel Switch – Lighted	24, 32	10@24V, 6.5@32V	3-1/4 x 2 (83 x 51)
45	3-Way Panel Switch	12, 24, 32	20@12V, 10@24V, 6.5@32V	2-1/4 x 2 (57 x 51)
43	3-Way Rocker Panel Switch – Lighted	12	20	2-7/8 x 2-3/8 (73 x 60)
44	3-Way Rocker Panel Switch – Lighted	24	10	2-7/8 x 2-3/8 (73 x 60)
49	2-Way Panel Switch	12, 24, 32	20@12V, 10@24V, 6.5@32V	2-1/4 x 2 (57 x 51)

02 Bilge Pumping Systems

GENERAL PURPOSE PUMPS



Shower Drain

A compact, full-capacity shower drain system. Automatically turns on after the water starts and shuts off when the water is removed. Activated by a non-mercury Rule-a-Matic® Plus™ Float Switch. Available with one or three inlet ports which offer varying combinations of inlet hose. Other features include a clear screw-down cover, a removable strainer for easy cleaning and an internal check valve to prevent back flow.



CAPACITY GPH (LPH)	MODEL NUMBER	VOLTS	FUSE SIZE	AMPS	HEIGHT INCHES (mm)	WIDTH INCHES (mm)	LENGTH INCHES (mm)	DISCHARGE INCHES (mm)	INTAKE FITTINGS INCHES (mm)
800 (3028)	98A	12DC	5	2.8@12V	5.25 (140)	8.25 (210)	11.25 (241)	3/4 (19)	3/4 (19), 3/4 x 1 (19 x 25) Stepped, 1-1/8 x 1-1/2 (29 x 38) Stepped
800 (3028)	98A-24	24DC	2.5	1.3@24V	5.25 (140)	8.25 (210)	11.25 (241)	3/4 (19)	3/4 (19), 3/4 x 1 (19 x 25) Stepped, 1-1/8 x 1-1/2 (29 x 38) Stepped

General Purpose Centrifugal Pumps

The Rule General Purpose Pump is designed for use as a washdown pump and/or to circulate water to your livewell tanks. Heavy-duty construction for commercial or pleasure boat use. 1-1/2" (38mm) inlet and 1-1/2" (38mm) discharge outlet. The Rule General Purpose Pump must be mounted below the waterline. It does not deliver high pressure, nor is it self-priming, but it delivers lots of water.



CAPACITY GPH (LPH)	MODEL NUMBER	VOLTS	FUSE SIZE	AMPS	HEIGHT INCHES (mm)	WIDTH INCHES (mm)	LENGTH INCHES (mm)	DISCHARGE INCHES (mm)	INTAKE INCHES (mm)
3800 (14380)	17A	12DC	25	15.5@12V	5.5 (140)	6.5 (165)	8.5 (216)	1.5 (38)	1.5 (38)
3700 (14002)	18A	24DC	15	6.9@24V	5.5 (140)	6.5 (165)	8.5 (216)	1.5 (38)	1.5 (38)
3700 (14002)	19A	32DC	10	5.0@32V	5.5 (140)	6.5 (165)	8.5 (216)	1.5 (38)	1.5 (38)

High-Water Bilge Alarms

The High-Water Bilge Alarm consists of a float switch and an in-dash gauge that features both a visual and audible 85 db alarm. This unit allows an unmanned compartment to be constantly monitored. For additional compartments, add additional Rule Float Switches. Complies with CFR 182.530, which requires a visual and audible alarm in each unmanned space on commercial vessels at least 26' (7.9m) in length.



SIZE	2-1/4" x 5" x 2-1/64" (5.7 x 12.7 x 5.1cm)
AMP	For use with pumps with a current draw of up to 20 amps @ 12 volts
VOLTAGE	12V DC-32V DC

MODEL	DESCRIPTION
33ALA	12V DC
32ALA	24V DC
31ALA	32V DC
M-1507	Alarm only

Portable Pumps

Constructed of sturdy ABS plastic with a comfort-grip handle providing smooth, firm strokes. Available in 24" (61cm) with hose and 48" (122cm) with hose.



MODEL	CAPACITY GPH (LPH)	ID HOSE SIZE	SIZE
165	8 (30)	1-1/8" (29mm)	24" (61cm) with 2' (0.6m) of 1-1/8" (29mm) hose
168	10 (38)	1-1/8" (29mm)	36" (91cm) with 4' (1.2m) of 1-1/8" (29mm) hose

02 Bilge Pumping Systems

JABSCO & RULE ACCESSORIES



Corrugated White Polyethylene Bilge Hoses



All Rule hoses are designed for use with Rule pumps. Sizes up to and including 1-1/2" (38mm) diameter have smooth mounting cuffs every 12" (305mm). Flexible for easy installation and resistant to detergents, oil, gasoline, diesel fuel and salt water.

MODEL	DESCRIPTION
80	1-1/8" (29mm) ID hose in 100' (31m) lengths
81	3/4" (19mm) ID hose in 100' (31m) lengths
88	1-1/2" (38mm) ID hose in 100' (31m) lengths
90	2" (51mm) ID hose in 50' (15m) lengths

Through Hull Fittings

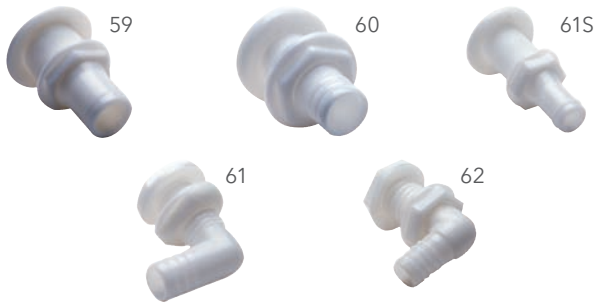

High-impact plastic will not rust, corrode or discolor. Specially designed for Rule pumps.

MODEL	DESCRIPTION
59	1-1/2" (38mm) straight
60	1-1/8" (29mm) straight
61S	3/4" (19mm) straight
61	3/4" (19mm) right angle
62	5/8" (16mm) right angle

Deluxe PVC Ribbed Bilge Hose



Clear ribbed bilge hose. Smooth inside finish improves pump performance. Rigid helix provides excellent abrasion resistance.

MODEL	DESCRIPTION
82	3/4" (19mm) ID hose in 100' (31m) lengths
83	1-1/8" (29mm) ID hose in 100' (31m) lengths
84	1-1/2" (38mm) ID hose in 100' (31m) lengths

Adapters



90° elbow adapters are designed for rigid pipe installations of sump and utility pumps. Adapters snap onto discharge port. Opposite end is female pipe threaded. High-impact plastic will not rust, corrode or discolor. Garden hose adapter snaps onto discharge port, converting pump into standard garden hose fitting.

MODEL	DESCRIPTION
57	Adapts 1800 GPH (6814 LPH) pump to 1" (25mm) NPT. Fits 1-1/8" (29mm) discharge.
67	Hose adapter – 1-1/2" (38mm) outlet to 1-1/8" (29mm) hose. Fits 1-1/2" (38mm) discharge.
68	Garden hose adapter – 1-1/8" (29mm) outlet to standard garden hose fitting. Fits 1-1/8" (29mm) discharge.
69	Double-stepped straight adapts 1-1/8" (29mm) outlet to 3/4" (19mm) or 5/8" (16mm) ID hose. Fits inside 1-1/8" (29mm) discharge. Not suitable for use with Rule-Mate pumps.

Replacement Strainer Bases



Original replacement strainer base for your Rule Bilge Pump.

MODEL	DESCRIPTION
275	Round Rule pumps, 360 to 1100 GPH
276	Black Strainer Base for above models
277	Square Rule bilge pumps
278	Round Rule pumps, 1500 to 2000 GPH
279	Round Rule pumps, 2800 to 3700 GPH
1000864-26	Rule-Mate Bilge Pumps, 500 to 1100 GPH – Fits 2009 to current models
286	Rule-Mate Bilge Pumps, 1500 to 2000 GPH
99A	Plastic strainer with side-mounting steel bracket for Rule-Mate 500 to 1100 GPH
70	Stainless Steel Debris Strainer – Fits Rule pumps up to 3700 GPH

Side Mount Bracket

Permits small Rule bilge pumps to be side mounted to a vertical stringer, bulkhead or transom. Use this bracket when bottom mounting is inconvenient or impossible. Simply remove the strainer from the pump, put the bracket in place and reassemble.



MODEL	DESCRIPTION
66	Round pumps, 360 to 1100 GPH

3-Way Fittings



Rule offers convenient "T" and "Y" fittings in popular hose sizes.

MODEL	DESCRIPTION
212	Y Fitting, 3/4" (19mm) hose
213	Y Fitting, 1-1/8" (29mm) hose
215	T Fitting, 3/4" (19mm) hose
216	T Fitting, 1-1/8" (29mm) hose

Vented Loops

For use in bilge pump installations to prevent siphoning of water back into boat from through hull. Duckbill one-way valve system incorporated in the top of the loop allows air to enter the line when not in use, yet effectively seals as water passes through.



MODEL	DESCRIPTION
260	3/4" (19mm) Vented Loop
261	1-1/8" (29mm) Vented Loop

Shower Drain Check Valve



MODEL	DESCRIPTION
M-1086	Check valve for shower drain box

02 Bilge Pumping Systems

AMAZON MANUAL DIAPHRAGM PUMPS



Amazon Bulkhead

For mounting on bulkhead or deck.

- Repositionable ports and body offer an amazing 96 assembly variations.
- Corrosion-resistant materials throughout.
- Stainless steel handle supplied with mounting.

MOUNTING POSITION

On Bulkhead

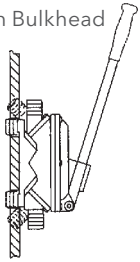

Port Positions



FLOW	12 GPM (45 LPM)
SELF-PRIMING	Up to 13' (4m)
FITTING	Connections for 1" (25mm) ID hose
SIZE	7" wide x 4-3/4" high x 8" deep (18cm x 12cm x 20cm)
WEIGHT	1.4lb (0.6kg)

MODEL	DESCRIPTION
29240-0000	Bulkhead Pump with detachable handle
29246-1000	Service Kit

For service and spare parts listing, see page 244.

Bilge Strainers

Stop bilge debris from blocking inlet suction hose and reduce the risk of debris entering and blocking the pump.

- Non-return valve fitted to stop bilge water draining back when pumping stops.
- Repositionable ports allow horizontal, vertical or sideways hose attachments.
- Easily removable strainer plate for cleaning.
- Corrosion-resistant materials throughout.



FITTING	Connections for 3/4", 1" or 1-1/2" (19mm, 25mm or 38mm) ID hose
SIZE	6-3/4" long x 2-3/4" wide x 2-1/2" high (17cm x 7.2cm x 6cm)
WEIGHT	0.25lb (0.1kg)

MODEL	DESCRIPTION
29290-1020	Bilge Strainer for 3/4" (19mm) ID hose
29290-1000	Bilge Strainer for 1" (25mm) ID hose
29290-1010	Bilge Strainer for 1-1/2" (38mm) ID hose

Amazon Universal

For mounting on bulkhead, through bulkhead, on deck or through deck.

- Unique safety feature allows operation from both inside and outside the cabin (with optional Through Deck Kit).
- Push-fit inlet and outlet elbows swivel through 360° to increase flexibility of installation still further.
- Corrosion-resistant materials throughout.
- Quick-release clamp ring gives fast access for blockage clearance.
- 1-1/2" (38mm) ports give excellent solids-handling ability for use with holding tanks.
- Stainless steel handle supplied with mounting clips and provision for safety lanyard.



MOUNTING POSITION

Through Deck

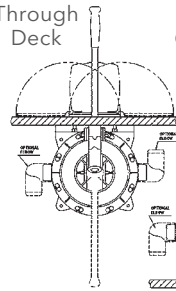

On Deck

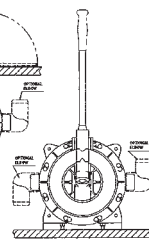

On Bulkhead

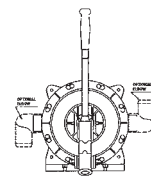

FLOW	25 GPM (100 LPM)
SELF-PRIMING	Up to 10' (3m)
FITTING	Connections for 1-1/2" (38mm) ID hose
SIZE	9-1/2" wide x 9-1/2" high x 6" deep (24cm x 24cm x 15cm)
WEIGHT	2.9lb (1.2kg)

MODEL	DESCRIPTION
29270-0000	Universal Pump with detachable handle and one Push-Fit Elbow
29279-0000	Optional Through Deck Kit
29266-1000	Additional Push-Fit Elbow
29276-1000	Service Kit

For service and spare parts listing, see page 245.

Amazon Thrudeck

For mounting through deck or through bulkhead.

- The ultimate compact through deck pump with no less than 16 port variations relative to the body.
- Loosening just one screw lets you clear blockages or position the body anywhere through 360° relative to the handle position.
- Compact design and low profile allow installation in confined spaces.
- Sleekly styled Through Deck Kit and cover, with four mounting positions relative to the pump.
- Excellent solids-handling ability for use with holding tanks.
- Corrosion-resistant materials throughout.
- Stainless steel handle supplied with mounting clips and provision for safety lanyard.

MOUNTING POSITION

Through Deck

360° Rotation

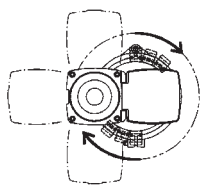
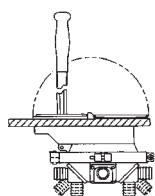

FLOW	13 GPM (50 LPM)
SELF-PRIMING	Up to 16' (5m)
FITTING	Connections for 1-1/2" (38mm) ID hose
SIZE	10" long x 4-5/16" wide x 4-1/2" deep (25cm x 11cm x 12cm)
WEIGHT	2.5lb (1.2kg)

MODEL	DESCRIPTION
29250-0000	1" (25mm) Thrudeck Pump with detachable handle and Through Deck Kit
29250-0010	1-1/2" (38mm) Thrudeck Pump with detachable handle and Through Deck Kit
29256-1000	Service Kit

For service and spare parts listing, see page 244.

In-Line Non-Return Valves

Non-return valves fit in a pump's suction hose to aid priming and prevent backflow of water into the bilges.

- Available for three hose sizes – 3/4", 1" and 1-1/2" (19mm, 25mm and 38mm).
- Simply fit into suction hose.
- Corrosion-resistant materials throughout.



FITTING	Connections for 3/4", 1" or 1-1/2" (19mm, 25mm or 38mm) ID hose
SIZE	4-1/4" long x 2-1/8" wide x 2" high (10.8cm x 5.5cm x 5cm)
WEIGHT	0.25lb (0.1kg)

Amazon Warrior

For mounting on deck or through deck (with optional Through Deck Kit and Bracket).

- Robust design particularly suited to workboats and larger leisure craft, or any installation where particularly heavy-duty use is anticipated.
- 29280-0100 model with swivel arms and captive wheel nuts meets DTI requirements for use on lifeboats.
- 18" (45cm) handle assists sustained high outputs of up to 35 GPM (135 LPM).
- Double diaphragm design gives maximum efficiency and added safety.
- 1-1/2" (38mm) ports give large solids-handling ability.
- Can function on one diaphragm in an emergency.
- Corrosion-resistant materials throughout.

MOUNTING POSITION

Through Deck

On Deck

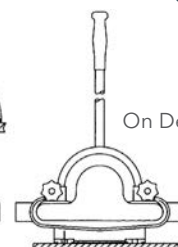
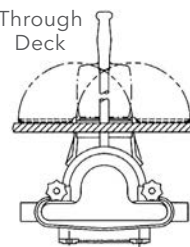

FLOW	35 GPM (135 LPM)
SELF-PRIMING	Up to 17.5' (5.5m)
FITTING	Connections for 1-1/2" (38mm) ID hose
SIZE	14" wide x 9-1/2" high x 8" deep (35.5cm x 24cm x 20cm)
WEIGHT	11lb (4.95kg)

MODEL	DESCRIPTION
29280-0000	Warrior Pump with detachable handle
29280-0100	Warrior Pump, lifeboat version
29279-0000	Optional Through Deck Kit
29289-0000	Under Deck Bracket (required for use with Through Deck Kit)
29286-1000	Service Kit

For service and spare parts listing, see page 245.

MODEL	DESCRIPTION
29295-1011	In-Line Non-Return Valve for 3/4" (19mm) ID hose
29295-1000	In-Line Non-Return Valve for 1" (25mm) ID hose
29295-1010	In-Line Non-Return Valve for 1-1/2" (38mm) ID hose

02 Bilge Pumping Systems

ELECTRIC DIAPHRAGM PUMPS



50880 Series Bilge Pump

Robust diaphragm pump suitable for bilge applications with a multi-positional pump head.

- 4.2 GPM (16 LPM) open flow output at 3' (1m) head.
- Allows mounting above wet bilges.
- Flexible installation.
- Compact and simple design.
- Filter-less.
- Quiet running.
- Capable of extensive dry running.
- Corrosion-resistant parts.
- Complies with USCG 183.410 and ISO 8846 MARINE (Ignition Protection).
- ISO 8849 MARINE (Bilge Pump Standard).



FLOW	4.2 GPM (16 LPM)
SELF-PRIMING	Up to 10' (3m) vertical lift
FITTING	Connections for 3/4" and 1" (19mm and 25mm) ID hose
SIZE	11.7" long x 5.9" wide x 4.4" high (29.7cm x 15cm x 11cm)
WEIGHT	6lb (2.7kg)

MODEL	DESCRIPTION
50880-1000	12V DC model, fuse 10 amp
50880-1100	24V DC model, fuse 5 amp
SK880	Service Kit

For service and spare parts listing, see page 231.

PAR 36680

Fully serviceable, bilge and deck wash pump.

- Allows mounting above wet bilges.
- Diaphragm design allows extended dry running.
- Complete with Pumpgard™ strainer.
- Complies with USCG 183.410 and ISO 8846 MARINE (Ignition Protection).
- ISO 8849 MARINE (Bilge Pump Standard).



FLOW	5.5 GPM (21 LPM)
SELF-PRIMING	Up to 7' (2m) vertical lift
FITTING	Connections for 3/4" (19mm) ID hose
SIZE	7-5/8" long x 6-1/2" wide x 8-1/2" high (19.4cm x 16.5cm x 21.6cm)
WEIGHT	8lb (6kg)

MODEL	DESCRIPTION
36680-2000	12V DC model, fuse 10 amp
36680-2010	24V DC model, fuse 6 amp
43990-0062	Service Kit (new -2XXX models only)

For service and spare parts listing, see page 233.

PAR 36600

Fully serviceable, bilge pump.

- Allows mounting above wet bilges.
- Diaphragm design allows extended dry running.
- Complete with Pumpgard™ strainer.
- Complies with USCG 183.410 and ISO 8846 MARINE (Ignition Protection).
- ISO 8849 MARINE (Bilge Pump Standard).



FLOW	7.9 GPM (30 LPM)
SELF-PRIMING	Up to 10' (3m) vertical lift
FITTING	Connections for 3/4" (19mm) ID hose
SIZE	8-5/8" long x 5-7/8" wide x 8-1/4" high (22cm x 15cm x 21cm)
WEIGHT	11lb (5kg)

MODEL	DESCRIPTION
36600-0000	12V DC model, fuse 15 amp
36600-0010	24V DC model, fuse 8 amp
30124-0000	Service Kit

For service and spare parts listing, see page 232.

31705 Series

- Self-priming up to 10' (3m).
- Run dry without damage.
- Smooth flow.
- Four piston, diaphragm pump.
- Powerful motor with thermal overload protection.
- Snap-in port fittings.



FLOW	4.3 GPM (16.3 LPM)
SELF-PRIMING	Up to 10' (3m) vertical lift
FITTING	Connections for 3/4" (19mm) ID hose
SIZE	7.73" long x 4.19" wide x 3.5" high (19.6cm x 10.6cm x 8.9cm)
WEIGHT	6.5lb (3kg)

MODEL	DESCRIPTION
31705-0092	12V DC model, fuse 15 amp
31705-0094	24V DC model, fuse 10 amp

For service and spare parts listing, see page 242.

31610 Series

- Self-priming up to 10' (3m).
- Run dry without damage.
- Smooth flow.
- Four piston, diaphragm pump.
- Powerful motor with thermal overload protection.
- Snap-in port fittings.



FLOW	3.5 GPM (13.2 LPM)
SELF-PRIMING	Up to 10' (3m) vertical lift
FITTING	Connections for 3/4" (19mm) ID hose
SIZE	7.73" long x 4.19" wide x 4.25" high (19.6cm x 10.6cm x 10.8cm)
WEIGHT	5lb (2.1kg)

MODEL	DESCRIPTION
31610-0092	12V DC model, fuse 10 amp
31610-0094	24V DC model, fuse 7 amp

For service and spare parts listing, see page 242.

Bilge Pumpgard™ Strainer

- Strainer protects all electric diaphragm bilge pumps.
- Prevents unnecessary pump breakdowns caused by particles in the water.
- Transparent housing allows instant inspection.
- 46200-0000 model installs in-line between bilge pickup and pump.
- Quick, in-place cleaning of the 20# mesh stainless steel screen.



FITTING	Connections for 3/4" (19mm) ID hose
SIZE	4-3/4" long x 2-3/4" wide x 2-1/2" high (12cm x 7cm x 6cm)
WEIGHT	0.5lb (0.2kg)

MODEL	DESCRIPTION
46200-0000	Model for 3/4" (19mm) ID hose
46200-0010	3/4" (19mm) ID hose x plug-in 90°
18753-0020	Replacement 20# Mesh Filter

For service and spare parts listing, see page 230.

02 Bilge Pumping Systems

ELECTRIC FLEXIBLE IMPELLER PUMPS



Water Puppy

Continuously rated duty bilge/sump pump.

- 6.33 GPM (23.83 LPM) output at 10' (3m) total head.
- Simple design means fewer wearing parts – all user serviceable.
- Complies with USCG 183.410 and ISO 8846 MARINE (Ignition Protection).
- ISO 8849 MARINE (Bilge Pump Standard).



FLOW	6.33 GPM (23.83 LPM)
SELF-PRIMING	Up to 4' (1.2m) vertical lift
FITTING	Connections for 1/2" (13mm) NPT male threads and for 1" (25mm) ID hose
SIZE	6-3/8" long x 4-3/4" wide x 3-1/2" high (16.2cm x 12.1cm x 8.9cm)
WEIGHT	6.5lb (37kg)

MODEL	DESCRIPTION
18660-0121	12V DC model, fuse 15 amp (Non CE)
6303-0001	Replacement Impeller
90061-0061	Service Kit

For service and spare parts listing, see page 226.

Maxi Puppy 3000

High-flow, continuously rated bilge pump offering good discharge head.

- 11 GPM (44 LPM) output at 10' (3m) total head.
- Bilge debris presents no problem to this bronze bodied, flexible impeller design.
- Simple design means fewer wearing parts – all user serviceable.
- ISO 8846 MARINE (Ignition Protection).
- ISO 8849 MARINE (Bilge Pump Standard).



FLOW	11 GPM (44 LPM)
SELF-PRIMING	Up to 8' (2.4m) vertical lift
FITTING	Connections for 1/2" (13mm) BSP male threads and for 1" (25mm) ID hose. Do not use plumbing of less than 3/4" (19mm) internal diameter.
SIZE	8-1/2" long x 4-3/4" wide x 3-1/2" high (22cm x 12cm x 9cm)
WEIGHT	8lb (3.6kg)

MODEL	DESCRIPTION
23610-3003	12V DC model, fuse 20 amp
23610-3103	24V DC model, fuse 10 amp
7273-0003	Replacement Impeller
SK224-1	Service Kit

For service and spare parts listing, see page 227.

Commercial Duty Water Puppy

High-flow, continuously rated bilge pump offering good discharge head.

- 7.83 GPM (29.5 LPM) output at 10' (3m) total head.
- Bilge debris presents no problem to this bronze bodied, flexible impeller design.
- Simple design means fewer wearing parts – all user serviceable.
- Complies with USCG 183.410 and ISO 8846 MARINE (Ignition Protection).
- ISO 8849 MARINE (Bilge Pump Standard).



FLOW	7.83 GPM (29.5 LPM)
SELF-PRIMING	Up to 8' (2.4m) vertical lift
FITTING	Connections for 1/2" (13mm) NPT male threads and for 1" (25mm) ID hose. Do not use plumbing of less than 3/4" (19mm) internal diameter.
SIZE	7-1/8" long x 4-3/4" wide x 3-1/2" high (18.1cm x 12.1cm x 8.9cm)
WEIGHT	8lb (2.7kg)

MODEL	DESCRIPTION
18670-0123	12V DC model, fuse 15 amp (Non CE)
18670-0943	24V DC model, fuse 10 amp (Non CE)
23680-4003	12V DC model, fuse 15 amp
23680-4103	24V DC model, fuse 10 amp
6303-0003	Replacement Impeller
90061-0061	Service Kit

For service and spare parts listing, see pages 226-227.

Junior Puppy

High discharge head continuously rated bilge pump.

- 3.75 GPM (15 LPM) output at 10' (3m) total head.
- Bilge debris presents no problem to this bronze bodied, flexible impeller design.
- Simple design means fewer wearing parts – all user serviceable.
- ISO 8846 MARINE (Ignition Protection).
- ISO 8849 MARINE (Bilge Pump Standard).



FLOW	3.75 GPM (15 LPM)
SELF-PRIMING	Up to 5' (1.5m) vertical lift
FITTING	Connections for 3/8" (10mm) BSP male threads and for 3/4" (19mm) ID hose
SIZE	7-1/8" long x 4-1/4" wide x 3-1/4" high (18cm x 11cm x 9cm)
WEIGHT	6.6lb (3kg)

MODEL	DESCRIPTION
23670-4003	12V DC model, fuse 15 amp
23670-4103	24V DC model, fuse 10 amp
SK400-0023	Service Kit, includes 9200-0003 Nitrile Impeller

For service and spare parts listing, see page 227.

Utility Puppy 2000

Continuous rated Utility Puppy 2000 offers high flow for bilge, deck wash and general purpose use, and ten minutes dry running.

- 8.33 GPM (32 LPM) output at 10' (3m) total head.
- Dry running for twenty minutes after initial use.
- Bilge debris presents no problem to this bronze bodied, flexible impeller design.
- Simple design means fewer wearing parts – all user serviceable.
- Complies with USCG 183.410 and ISO 8846 MARINE (Ignition Protection).
- ISO 8849 MARINE (Bilge Pump Standard).



FLOW	8.33 GPM (32 LPM)
SELF-PRIMING	Up to 4' (1.2m) vertical lift
FITTING	Connections for 3/4" (19mm) male threads
SIZE	7-1/2" long x 4-3/4" wide x 3-1/2" high (19cm x 12cm x 9cm)
WEIGHT	9.7lb (3.4kg)

MODEL	DESCRIPTION
23920-2403	12V DC BSP model, fuse 15 amp
23290-2503	24V DC BSP model, fuse 10 amp
23920-9403	12V DC NPT model, fuse 15 amp
23920-9503	24V DC NPT model, fuse 10 amp
SK416-0003	Service Kit

For service and spare parts listing, see page 227.

Utility Puppy 3000

Continuous rated heavy-duty Utility Puppy 3000 offers very high flow for bilge, deck wash and general purpose use, and ten minutes dry running.

- 11.33 GPM (43 LPM) output at 10' (3m) total head.
- Dry running for ten minutes after initial use.
- Mechanical seal for extra long life.
- Bilge debris presents no problem to this bronze bodied, flexible impeller design.
- Simple design means fewer wearing parts – all user serviceable.
- Complies with USCG 183.410 and ISO 8846 MARINE (Ignition Protection).
- ISO 8849 MARINE (Bilge Pump Standard).



FLOW	11.33 GPM (43 LPM)
SELF-PRIMING	Up to 8' (2.4m) vertical lift
FITTING	Connections for 3/4" (19mm) male threads
SIZE	8-1/2" long x 4-3/4" wide x 3-1/2" high (22cm x 12cm x 9cm)
WEIGHT	8lb (3.6kg)

MODEL	DESCRIPTION
23920-2213	12V DC BSP model, fuse 15 amp
23920-2313	24V DC BSP model, fuse 10 amp
23920-9213	12V DC NPT model, fuse 25 amp
23920-9313	24V DC NPT model, fuse 15 amp
SK415-0113	Service Kit

For service and spare parts listing, see page 227.

Mini Puppy

Compact, continuously rated low-flow pump.

- 1.38 GPM (5.5 LPM) output at 10' (3m) total head.
- Small bilge debris presents no problem to this brass bodied pump.
- Simple design means fewer wearing parts – all user serviceable.
- ISO 8846 MARINE (Ignition Protection).
- ISO 8849 MARINE (Bilge Pump Standard).



FLOW	1.38 GPM (5.5 LPM)
SELF-PRIMING	Up to 5' (1.5m) vertical lift
FITTING	Connections for 3/8" (10mm) BSP male threads and for 3/4" (19mm) ID hose
SIZE	6" long x 4-3/4" wide x 3-1/2" high (15cm x 12cm x 8cm)
WEIGHT	2lb (0.9kg)

MODEL	DESCRIPTION
23620-4003	12V DC model, fuse 5 amp
23620-4103	24V DC model, fuse 3 amp
SK374-0003	Service Kit, includes 1414-0003 Nitrile Impeller

For service and spare parts listing, see page 227.

02 Bilge Pumping Systems

ENGINE DRIVEN, ELECTRIC CLUTCH PUMPS



18330 Series Electric Clutch Pumps

This manually activated clutch pump offers all the benefits of flexible impeller pumps with a high capacity flow rate and horizontally oriented ports.

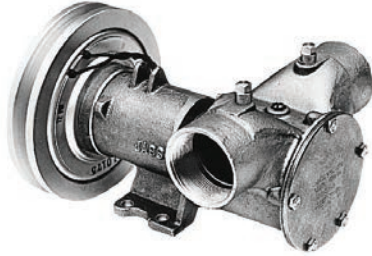

- 78.5 GPM (314 LPM) at 10' (3m) total head @ 1750 rpm.
- Mechanical face type shaft seal.
- Nitrile impeller.
- Two pulley options to accommodate either A or B size belts.
- Two single-row shaft ball bearings.

FLOW	78.5 GPM (314 LPM)
SELF-PRIMING	Up to 15' (4.5m) vertical lift
FITTING	2" (51mm) NPT
SIZE	12-7/16" long x 5-15/16" wide x 5-3/4" high (31.6cm x 15cm x 14.6cm), excluding pulley. Pulley diameter is 7" (17.8cm).
WEIGHT	24lb (11kg)

MODEL	DESCRIPTION
18330-0000	12V DC pump with double A groove pulley
18330-0001	24V DC pump with double A groove pulley
18330-0040	12V DC pump with single B groove pulley
18330-0041	24V DC pump with single B groove pulley

For service and spare parts listing, see page 216.

11870 Series Electric Clutch Pumps

This electrically activated clutch pump offers all the benefits of flexible impeller pumps with a substantial flow rate and horizontally oriented ports. The electric clutch offers convenient remote activation.



- 58.75 GPM (235 LPM) at 10' (3m) total head @ 1750 rpm.
- Mechanical face type shaft seal.
- Nitrile impeller.
- Two pulley options to accommodate either A or B size belts.
- Double row ball bearing.

FLOW	58.75 GPM (235 LPM)
SELF-PRIMING	Up to 15' (4.5m) vertical lift
FITTING	1-1/4" (32mm) NPT
SIZE	8-3/16" long x 5-7/8" wide x 5-1/2" high (20.8cm x 14.9cm x 14cm), excluding pulley. Pulley diameter is 7" (17.8cm).
WEIGHT	18lb (8kg)

MODEL	DESCRIPTION
11870-0005	12V DC pump with double A groove pulley
11870-0006	24V DC pump with double A groove pulley
11870-0045	12V DC pump with single B groove pulley
11870-0046	24V DC pump with single B groove pulley
11870-0007	32V DC pump with double A groove pulley

For service and spare parts listing, see page 216.

50580 Series Electric Clutch Pumps

Heavy-duty bilge and deck wash pump, belt driven from the engine, for leisure and commercial craft.



- 24.5 GPM (81.33 LPM) at 10' (3m) total head @ 1500 rpm.
- Bilge debris presents no problems to this robust, bronze bodied flexible impeller pump.
- Can be remotely controlled from outside the engine room, and can be automatically shut off by fitting a vacuum cut-off switch.
- Neoprene impeller is fitted as standard.

	NORTH AMERICAN	EUROPEAN
FLOW	24.5 GPM (81.33 LPM)	24.5 GPM (81.33 LPM)
SELF-PRIMING	Up to 15' (4.5m) vertical lift	Up to 15' (4.5m) vertical lift
FITTING	1" (25mm) NPT	1" (25mm) BSP internal thread
SIZE	6-1/2" long x 5" wide x 7" high (16cm x 12cm x 17.8cm)	6-1/2" long x 5" wide x 7" high (16cm x 12cm x 17.8cm)
WEIGHT	11lb (5kg)	11lb (5kg)

MODEL	DESCRIPTION
50580-9001	12V DC 2A pulley E/M clutch, fuse 5 amp
50580-9101	24V DC 2A pulley E/M clutch, fuse 2.5 amp
50580-9201	12V DC 1B pulley E/M clutch, fuse 5 amp
50580-9301	24V DC 1B pulley E/M clutch, fuse 2.5 amp

For service and spare parts listing, see page 217.

50270 Series Electric Clutch Pumps

Very heavy-duty bilge and deck wash pump, belt driven from the engine, for leisure and commercial craft.

- 68.33 GPM (272.5 LPM) at 10' (3m) total head @ 1500 rpm.
- Bilge debris presents no problems to this robust, bronze bodied flexible impeller pump.
- Can be remotely controlled from outside the engine room and can be automatically shut off by fitting a vacuum cut-off switch.
- Neoprene impeller is fitted as standard.

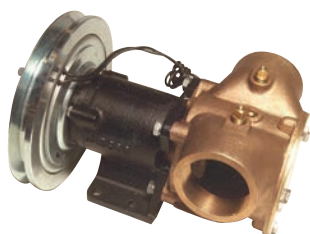

FLOW	68.33 GPM (272.5 LPM)
SELF-PRIMING	Up to 15' (4.5m) vertical lift
FITTING	2" (51mm) BSP internal thread, optional 2" (51mm) flange
SIZE	10" long x 7" wide x 7" high (26.4cm x 17.8cm x 17.8cm)
WEIGHT	27lb (12.2kg)

MODEL	DESCRIPTION
50270-X011	12V DC 2A pulley E/M clutch, fuse 5 amp
50270-X111	24V DC 2A pulley E/M clutch, fuse 2.5 amp
50270-X211	12V DC 1B pulley E/M clutch, fuse 5 amp
50270-X311	24V DC 1B pulley E/M clutch, fuse 2.5 amp
X=0, flanged ports; X=2, BSP ports	
For service and spare parts listing, see page 217.	

50220 Series Electric Clutch Pumps

Very heavy-duty bilge, deck wash and firefighting pump, belt driven from the engine, for leisure and commercial craft.

- 48.75 GPM (195 LPM) at 10' (3m) total head @ 1500 rpm.
- Bilge debris presents no problems to this robust, bronze bodied flexible impeller pump.
- Can be remotely controlled from outside the engine room, and can be automatically shut off by fitting a vacuum cut-off switch.
- Neoprene impeller is fitted as standard.



FLOW	48.75 GPM (195 LPM)
SELF-PRIMING	Up to 15' (4.5m) vertical lift
FITTING	1-1/2" (38mm) flange
SIZE	9-1/2" long x 6" wide x 7" high (23.9cm x 15.3cm x 17.8cm)
WEIGHT	25lb (11.2kg)

MODEL	DESCRIPTION
50220-0011	12V DC 2A pulley E/M clutch, fuse 5 amp
50220-0111	24V DC 2A pulley E/M clutch, fuse 2.5 amp
50220-0211	12V DC 1B pulley E/M clutch, fuse 5 amp
50220-0311	24V DC 1B pulley E/M clutch, fuse 2.5 amp
For service and spare parts listing, see page 217.	

50200 Series Electric Clutch Pumps

Very heavy-duty bilge, deck wash and firefighting pump, belt driven from the engine, for leisure and commercial craft.

- 48.75 GPM (195 LPM) at 10' (3m) total head @ 1500 rpm.
- Bilge debris presents no problems to this robust, bronze bodied flexible impeller pump.
- Can be remotely controlled from outside the engine room, and can be automatically shut off by fitting a vacuum cut-off switch.
- Neoprene impeller is fitted as standard.



FLOW	48.75 GPM (195 LPM)
SELF-PRIMING	Up to 15' (4.5m) vertical lift
FITTING	1-1/2" (38mm) BSP internal thread
SIZE	9-1/2" long x 6" wide x 7" high (23.9cm x 15.3cm x 17.8cm)
WEIGHT	25lb (11.2kg)

MODEL	DESCRIPTION
50200-2011	12V DC 2A pulley E/M clutch, fuse 5 amp
50200-2111	24V DC 2A pulley E/M clutch, fuse 2.5 amp
50200-2211	12V DC 1B pulley E/M clutch, fuse 5 amp
50200-2311	24V DC 1B pulley E/M clutch, fuse 2.5 amp
50200-9303	24V DC 1B pulley E/M clutch, fuse 3 amp
For service and spare parts listing, see page 217.	

02 Bilge Pumping Systems

ENGINE DRIVEN, MANUAL CLUTCH PUMPS



51200 Series Manual Clutch Pumps

Heavy-duty bilge and deck wash pump, belt driven from the engine, for leisure and commercial craft.

- 48.75 GPM (195 LPM) at 10' (3m) total head @ 1500 rpm.
- Bilge debris presents no problems to this robust, bronze bodied flexible impeller pump.
- Dependable manual control will operate even under the toughest conditions.
- Clutch pulley will accommodate both A and B type pulley belts.
- Easily serviced and maintained.
- Neoprene impeller is fitted as standard, optional nitrile impeller available.

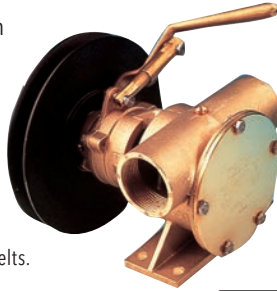

FLOW	48.75 GPM (195 LPM)
SELF-PRIMING	Up to 15' (4.5m) vertical lift
FITTING	1-1/2" (38mm) BSP internal thread
SIZE	9-1/2" long x 6" wide x 9" high (24.4cm x 15cm x 22.6cm)
WEIGHT	18lb (8kg)

MODEL	DESCRIPTION
51200-2011	Manual clutch
For service and spare parts listing, see page 214.	

51200-9013 Manual Clutch Pumps

This manually activated clutch pump offers all the benefits of flexible impeller pumps with a substantial flow rate.

- 48.75 GPM (195 LPM) at 10' (3m) total head @ 1500 rpm.
- Mechanical face type shaft seal.
- Nitrile impeller.
- Clutch pulley accommodates both A and B size belts.
- Double row ball bearing.

FLOW	48.75 GPM (195 LPM)
SELF-PRIMING	Up to 15' (4.5m) vertical lift
FITTING	1-1/2" (38mm) NPT
SIZE	9-5/8" long x 5-15/16" wide x 8-7/8" high (24.5cm x 15.1cm x 22.5cm), excluding pulley. Pulley diameter is 7" (17.8cm).
WEIGHT	18lb (8kg)

MODEL	DESCRIPTION
51200-9013	Pump with nitrile impeller, full cam and mechanical seal
For service and spare parts listing, see page 214.	

51270 Series Manual Clutch Pumps

Very heavy-duty bilge, deck wash and firefighting pump, belt driven from the engine, for leisure and commercial craft.

- 68.33 GPM (272.5 LPM) at 10' (3m) total head @ 1500 rpm.
- Bilge debris presents no problems to this robust, bronze bodied flexible impeller pump.
- Dependable manual control will operate even under the toughest conditions.
- Clutch pulley will accommodate both A and B type pulley belts.
- Easily serviced and maintained.
- Neoprene impeller is fitted as standard.



FLOW	68.33 GPM (272.5 LPM)
SELF-PRIMING	Up to 15' (4.5m) vertical lift
FITTING	2" (51mm) BSP internal thread, optional 2" (51mm) flange
SIZE	12" long x 7" wide x 9" high (31.6cm x 17cm x 22.4cm)
WEIGHT	25lb (11kg)

MODEL	DESCRIPTION
51270-0011	Manual clutch, flanged ports
51270-2011	Manual clutch, BSP ports
For service and spare parts listing, see page 214.	

51270-9013 Manual Clutch Pumps

This manually activated clutch pump offers all the benefits of flexible impeller pumps with a high capacity flow rate and horizontally oriented ports. Very heavy-duty bilge, deck wash and firefighting pump, belt driven from the engine, for leisure and commercial craft.

- 68.33 GPM (272.5 LPM) at 10' (3m) total head @ 1500 rpm.
- Mechanical face type shaft seal.
- Nitrile impeller.
- Clutch pulley accommodates both A and B size belts.
- Two single-row shaft ball bearings.

FLOW	68.33 GPM (272.5 LPM)
SELF-PRIMING	Up to 15' (4.5m) vertical lift
FITTING	2" (51mm) NPT
SIZE	12-7/16" long x 5-15/16" wide x 8-7/8" high (31.6cm x 15.1cm x 22.5cm), excluding pulley. Pulley diameter is 7" (17.8cm).
WEIGHT	24lb (11kg)

MODEL	DESCRIPTION
51270-9013	Pump with nitrile impeller, full cam and mechanical seal
For service and spare parts listing, see page 214.	

51580 Series Manual Clutch Pumps

Heavy-duty bilge and deck wash pump, belt driven from the engine, for leisure and commercial craft.

- 24.5 GPM (81.33 LPM) at 10' (3m) total head @ 1500 rpm.
- Bilge debris presents no problems to this robust, bronze bodied flexible impeller pump.
- Dependable manual control will operate even under the toughest conditions.
- Clutch pulley will accommodate both A and B type pulley belts.
- Easily serviced and maintained.
- Neoprene impeller is fitted as standard.

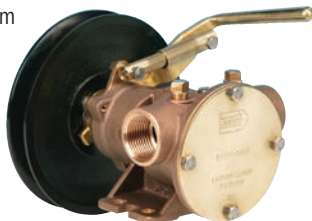

FLOW	24.5 GPM (81.33 LPM)
SELF-PRIMING	Up to 15' (4.5m) vertical lift
FITTING	1" (25mm) BSP internal thread
SIZE	8" long x 5" wide x 7-1/2" high (19.8cm x 12cm x 18.9cm)
WEIGHT	11lb (5kg)

MODEL	DESCRIPTION
51580-2001	Manual clutch

51580-9001 Manual Clutch Pumps

This manually activated clutch pump offers all the benefits of flexible impeller pumps with a moderate flow rate and horizontally oriented ports.

- 24.5 GPM (81.33 LPM) at 10' (3m) total head @ 1500 rpm.
- Mechanical face type shaft seal.
- Neoprene impeller.
- Clutch pulley accommodates both A and B size belts.
- Spaced sealed for life bearings.

FLOW	24.5 GPM (81.33 LPM)
SELF-PRIMING	Up to 15' (4.5m) vertical lift
FITTING	1" (25mm) NPT
SIZE	7-13/16" long x 4-3/4" wide x 7-9/16" high (19.8cm x 12.1cm x 19.2cm), excluding pulley. Pulley diameter is 6" (15.2cm).
WEIGHT	9lb (4kg)

MODEL	DESCRIPTION
51580-9001	Pump with manual clutch

51220 Series Manual Clutch Pumps

Very heavy-duty bilge, deck wash and firefighting pump, belt driven from the engine, for leisure and commercial craft.

- 45.42 GPM (195 LPM) at 10' (3m) total head @ 1500 rpm.
- Self-priming up to 15' (4.5m) vertical lift.
- Bilge debris presents no problems to this robust, bronze bodied flexible impeller pump.
- Dependable manual control will operate even under the toughest conditions.
- Clutch pulley will accommodate both A and B type pulley belts.
- Easily serviced and maintained.
- Neoprene impeller is fitted as standard.



FLOW	45.42 GPM (195 LPM)
SELF-PRIMING	Up to 15' (4.5m) vertical lift
FITTING	1-1/2" (38mm) flange
SIZE	11-1/2" long x 6" wide x 9" high (29.2cm x 15.2cm x 22.6cm)
WEIGHT	22lb (10kg)

MODEL	DESCRIPTION
51220-0011	Manual clutch

For service and spare parts listing, see page 214.

6590-0005 Manual Clutch Pumps

This manually activated clutch pump offers all the benefits of flexible impeller pumps with a substantial flow rate and horizontally oriented ports.

- 58.92 GPM (235 LPM) at 10' (3m) total head @ 1750 rpm.
- Nitrile impeller.
- Clutch pulley accommodates a B size belt.
- Double row ball bearing.



FLOW	58.92 GPM (235 LPM)
SELF-PRIMING	Up to 10' (3m) vertical lift
FITTING	1-1/4" (32mm) NPT
SIZE	8-1/16" long x 5-1/2" wide x 8-1/8" high (20.5cm x 14cm x 20.6cm), excluding pulley. Pulley diameter is 6" (15.2cm).
WEIGHT	18lb (8kg)

MODEL	DESCRIPTION
6590-0005	Pump with nitrile impeller, full cam and mechanical seal

For service and spare parts listing, see page 172.

02 Bilge Pumping Systems

JABSCO ACCESSORIES



Y-Valve



Robust Y-Valve for use in bilge applications. Allows two bilge sections to be emptied by one pump.

- Rotating ports allow routing of hoses onto the valve from almost any direction.
- Can be operated through bulkhead by use of optional handle extension.
- Waste and corrosion-resistant construction throughout.
- Can be padlocked.

FITTING	Connections for two 1-1/2" (38mm) ports and extra 1" (25mm) straight inlet port
SIZE	7-5/8" long x 7-1/4" wide x 4-5/8" high (20cm x 19cm x 12cm)
WEIGHT	2lb (0.9kg)

MODEL	DESCRIPTION
45490-1000	Y-Valve
45500-1000	Handle Extension Kit
45493-0000	Replacement Handle
18753-0661	Replacement Ports Kit
45488-0000	Service Kit

Bilge Strainers with Non-Return Valves



Stop bilge debris from blocking inlet suction hose and reduce the risk of debris entering and blocking the pump.

- Non-return valve fitted to stop bilge water from draining back when pumping stops.
- Repositionable ports allow horizontal, vertical or sideways hose attachments.
- Easily removable strainer plate for cleaning.
- Corrosion-resistant materials throughout.

FITTING	Connections for 3/4", 1" or 1-1/2" (19mm, 25mm or 38mm) ID hose
SIZE	6-3/4" long x 2-3/4" wide x 2-1/2" high (17cm x 7.2cm x 6cm)
WEIGHT	0.25lb (0.1kg)

MODEL	DESCRIPTION
29290-1020	Bilge Strainer for 3/4" (19mm) ID hose
29290-1000	Bilge Strainer for 1" (25mm) ID hose
29290-1010	Bilge Strainer for 1-1/2" (38mm) ID hose

Vacuum Switch

Protects any 12V or 24V DC electric or electromagnetic clutch bilge pump up to 15 amp from dry running drainage – especially flexible impeller designs.

- Manual start, automatic stop – remote start possible.
- Vacuum sensor shuts off power to pump motor or clutch when bilges are clear.
- Simply mounts between bilges and pump.
- Some Jabsco pumps have integral mounting point.

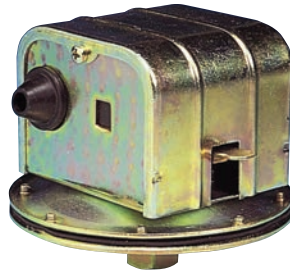

FITTING	Connection for 1/4" (6mm) female thread and supplied with 1/4" (6mm) close nipple. Suitable for 12 and 24 volt DC; 220 volt AC, up to 15 amp; 110 volt AC up to 10 amp. For remote start, install 15 amp push button next to Master Switch.
SIZE	4" diameter x 3-1/2" high (11cm x 9cm)
WEIGHT	1.5lb (0.7kg)

MODEL	DESCRIPTION
4732-0000	Vacuum Switch



WARNING

Jabsco Vacuum Switch is not ignition protected.
Do not install where flammable vapors are present.